

MAXIMUM SOLUTIONS

New Low Profile Target Connectors

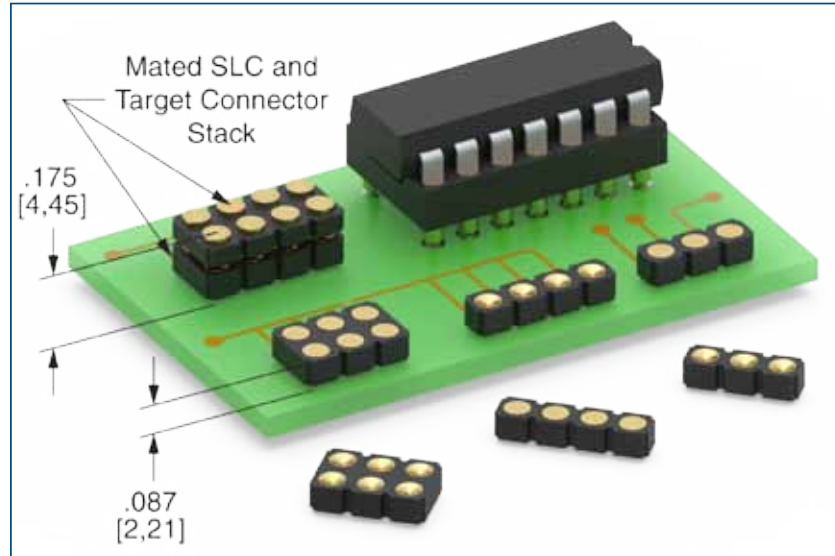

Mill-Max is excited to announce the release of our lowest profile target connectors with an above board height of only .087" (2,21mm). Target connectors are used in place of SMT pads on a PCB as the mating surface for spring-loaded pins. They provide increased durability and are useful in achieving specific distances between boards.

To augment our existing .100" (2,54mm) grid target connector lineup we are introducing four new, low profile products. These connectors are all surface mount, available in single or double row packages and are offered with flat or concave target faces. Concave face targets provide additional surface area for mating and can aid in centering/alignment of components and/or boards fitted with spring-loaded connectors. Precision-machined pins with an overall length tolerance of +/- .0015" (+/- .0381mm) help to achieve a co-planarity of .005" (.13mm) or better for connectors up to 1" (25,4mm) long. Advanced machining techniques are used to ensure no burr protrusion on either the target face or the surface mount termination end.

Here is the part number breakdown for these new connectors:

Part Number	Number of Rows	Target Face Style
319-10-1XX-30-540000	Single	Flat
319-10-1XX-30-550000	Single	Concave
419-10-2XX-30-540000	Double	Flat
419-10-2XX-30-550000	Double	Concave

(3/17) -- PR674)

Mill-Max Mfg. Corp. • 190 Pine Hollow Road, Oyster Bay, NY 11771
516-922-6000 • Fax: 516-922-9253 • www.mill-max.com



Combining target connectors with spring-loaded connectors on opposing boards can be a simple and convenient solution for making connections between stacked boards or docking stations and devices. These new connectors are ideally suited for low profile applications where multiple connections are required. To achieve an ultra-low profile mated pair using these target connectors, the [Mill-Max series 815 and 817](#) (single and double row respectively) are the ideal choice. The 815/817 connectors, compressed to ½ stroke and used in combination with these new low profile target connectors, provide a board to board spacing of just .175" (4,45mm).

All the pins are precision-machined and gold-plated for environmental protection, durability and good conductivity. The connector insulators are molded from high temperature plastic suitable for most soldering process including RoHS environments. All of these products are RoHS compliant. See the attached catalog pages for further details.

For more information, please visit: www.mill-max.com/PR674.

SPRING-LOADED CONNECTORS



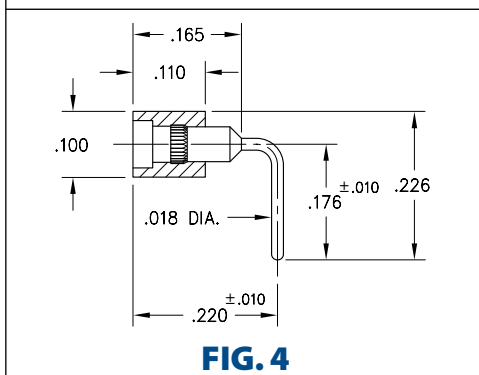
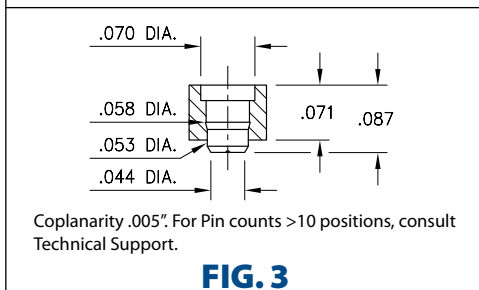
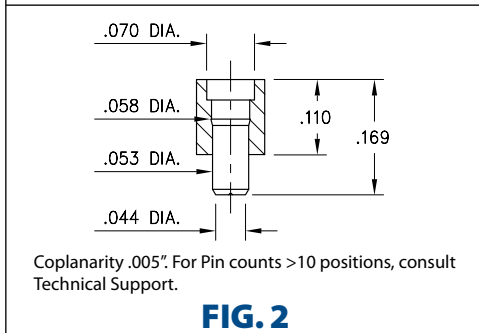
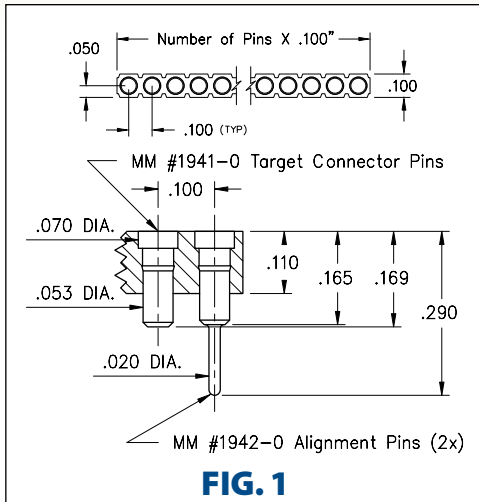

SERIES 319, 399 • .100" GRID TARGET CONNECTORS FOR SPRING-LOADED ASSEMBLIES • SINGLE ROW STRIPS

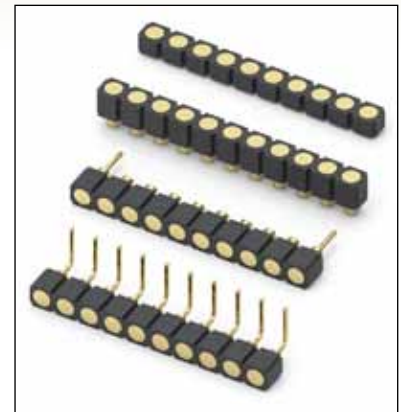

- Series 319 and 399 Spring Target Connectors, supplied in single row strips. Available in SMT and right angle through-hole termination configurations
- Target Connectors provide an excellent gold-plated conductive mating surface for spring loaded connectors. These series are offered with a flat face for making contact with our standard .042" dia. spring pin plungers
- Target connectors use MM #1940, #1941/1942, #1953 and #1954 pins. See pages 218 & 223.3 for details
- Insulators are high temperature thermoplastic



ORDERING INFORMATION

FIG. 1	Series 319...041 Surface Mount w/ Alignments Pins
	319-10-1__-30-041000 Specify number of pins 03-64
FIG. 2	Series 319...008 Surface Mount
	319-10-1__-30-008000 Specify number of pins 01-64
FIG. 3	Series 319...054 Low Profile Surface Mount
	319-10-1__-30-054000 Specify number of pins 01-64
FIG. 4	Series 399...008 Right Angle Solder Tails
	399-10-1__-10-008000 Specify number of pins 01-64
  	
SPECIFY PLATING CODE XX=	10 
Pin Plating 	10 μ" Au



SPRING-LOADED CONNECTORS

SERIES 319, 399 • .100" GRID CONCAVE FACE TARGET CONNECTORS FOR SPRING-LOADED ASSEMBLIES • SINGLE ROW STRIPS

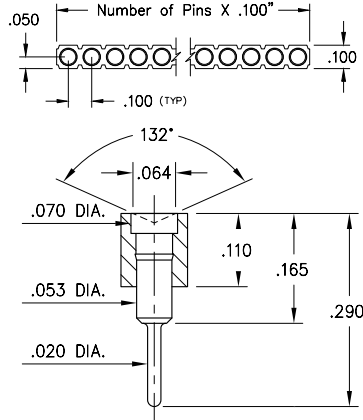
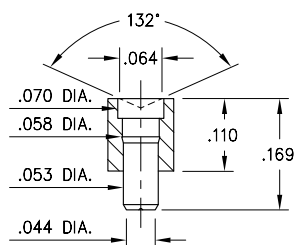
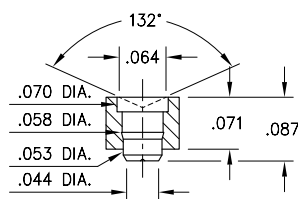

FIG. 1



Coplanarity .005". For Pin counts >10 positions, consult Technical Support.

FIG. 2



Coplanarity .005". For Pin counts >10 positions, consult Technical Support.

FIG. 3

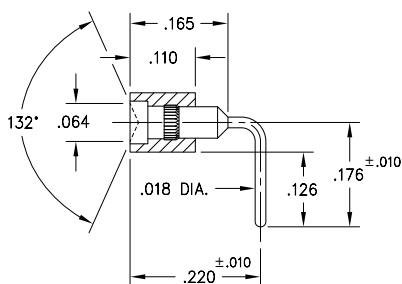

FIG. 4

- Series 319 and 399 Spring Target Connectors, supplied in single row strips. Available in SMT and right angle through-hole termination configurations
- Target Connectors provide an excellent gold-plated conductive mating surface for spring loaded connectors. These series are offered with a concave face for making contact with our standard .042" dia. spring pin plungers
- Target connectors use MM #1948, #1955, #1957 and #1960 pins. See pages 223.1, 223.2 and 223.3 for details
- Insulators are high temperature thermoplastic



ORDERING INFORMATION

	Series 319...006	Standard Solder Tails
FIG. 1	319-10-1	-00-006000 Specify number of pins 01-64
FIG. 2	Series 319...007	Surface Mount
	319-10-1	-30-007000 Specify number of pins 01-64
FIG. 3	Series 319...055	Low Profile Surface Mount
	319-10-1	-30-055000 Specify number of pins 01-64
FIG. 4	Series 399...007	Right Angle Solder Tails
	399-10-1	-10-007000 Specify number of pins 01-64
<div style="display: flex; justify-content: space-around; align-items: center;"> <div style="border: 1px solid green; padding: 5px; color: white;">RoHS-2 2011/65/EU</div> <div style="border: 1px solid black; border-radius: 50%; padding: 5px;">XX=Plating Code See Below</div> <div style="border: 1px solid black; border-radius: 50%; padding: 5px;">For Electrical, Mechanical & Environmental Data, See page 264</div> </div>		
SPECIFY PLATING CODE XX=		
Pin Plating	10 ◆	10 μ" Au



SPRING-LOADED CONNECTORS

SERIES 419, 499 • .100" GRID TARGET CONNECTORS FOR SPRING-LOADED ASSEMBLIES • DOUBLE ROW STRIPS

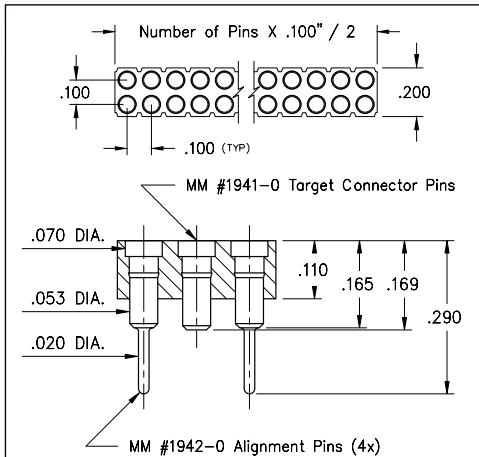

FIG. 1

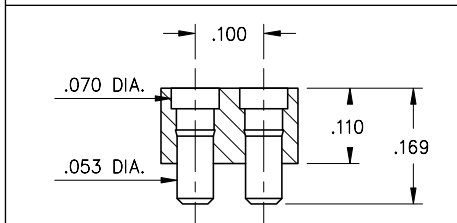

FIG. 2

Coplanarity .005" For Pin counts >20 positions, consult Technical Support.

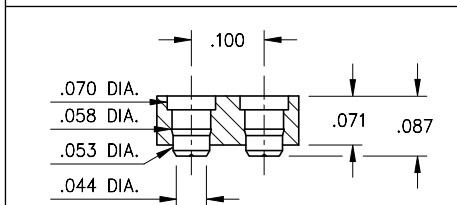

FIG. 3

Coplanarity .005" For Pin counts >20 positions, consult Technical Support.

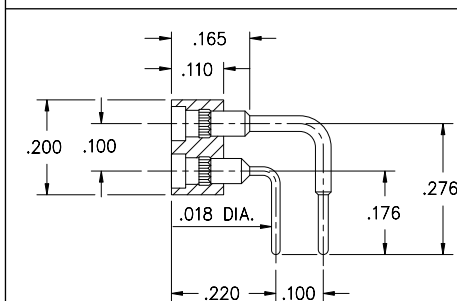

FIG. 4

- Series 419 and 499 Spring Target Connectors, supplied in double row strips. Available in SMT and right angle through-hole termination configurations
- Target Connectors provide an excellent gold-plated conductive mating surface for spring loaded connectors. These series are offered with a flat face for making contact with our standard .042" dia. spring pin plungers
- Target connectors use MM #1940, #1941/1942, #1953 and #1954 pins. See pages 218 & 223.3 for details
- Insulators are high temperature thermoplastic



ORDERING INFORMATION

	Series 419...042	Surface Mount w/ Alignments Pins
FIG. 1	419-10-2	-30-042000 Specify number of pins → 06-72
FIG. 2	Series 419...041	Surface Mount 419-10-2 -30-041000 Specify number of pins → 04-72
FIG. 3	Series 419...054	Low Profile Surface Mount 419-10-2 -30-054000 Specify number of pins → 04-72
FIG. 4	Series 499...008	Right Angle Solder Tails 499-10-2 -10-008000 Specify number of pins → 04-64
<div style="display: flex; justify-content: space-around; align-items: center;"> <div style="border: 1px solid black; padding: 5px; background-color: #90EE90;">RoHS-2 2011/65/EU</div> <div style="border: 1px solid black; border-radius: 50%; padding: 5px;">XX=Plating Code See Below</div> <div style="border: 1px solid black; border-radius: 50%; padding: 5px;">For Electrical, Mechanical & Environmental Data, See page 264</div> </div>		
SPECIFY PLATING CODE XX=		
Pin Plating	10 ◆	10 μ" Au



SPRING-LOADED CONNECTORS

SERIES 419, 499 • .100" GRID CONCAVE FACE TARGET CONNECTORS FOR SPRING-LOADED ASSEMBLIES • DOUBLE ROW STRIPS

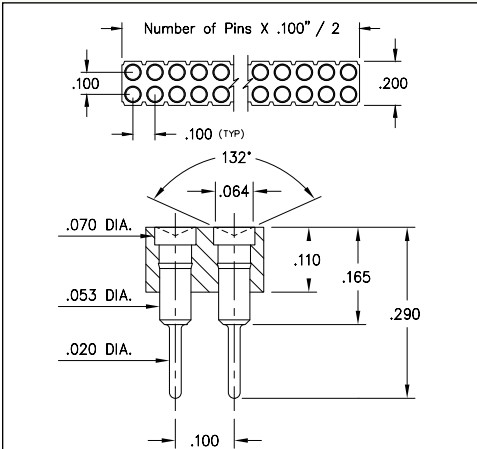
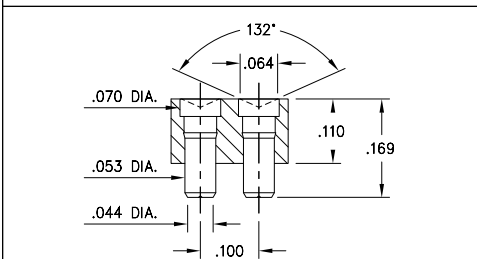
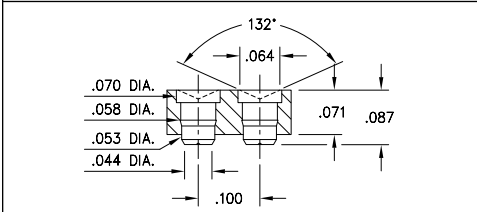

FIG. 1



Coplanarity .005". For Pin counts >20 positions, consult Technical Support.

FIG. 2



Coplanarity .005". For Pin counts >20 positions, consult Technical Support.

FIG. 3

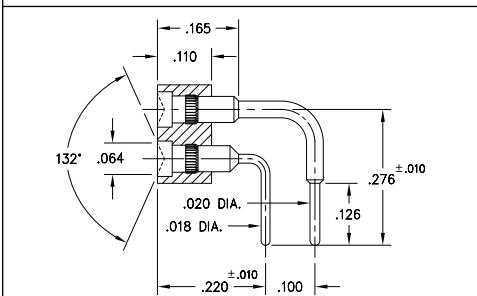
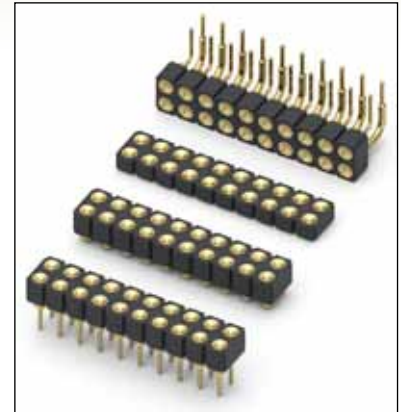

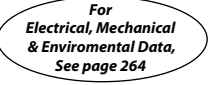

FIG. 4

- Series 419 and 499 Spring Target Connectors, supplied in double row strips. Available in SMT and right angle through-hole termination configurations
- Target Connectors provide an excellent gold-plated conductive mating surface for spring loaded connectors. These series are offered with a concave face for making contact with our standard .042" dia. spring pin plungers
- Target connectors use MM #1948, #1955, #1957 and #1958/1960 pins. See pages 223.1, 223.2 and 223.3 for details
- Insulators are high temperature thermoplastic



ORDERING INFORMATION

	Series 419...006	Standard Solder Tails
FIG. 1	419-10-2	-00-006000 Specify number of pins 04-64
FIG. 2	Series 419...007	Surface Mount
FIG. 2	419-10-2	-30-007000 Specify number of pins 04-72
FIG. 3	Series 419...055	Low Profile Surface Mount
FIG. 3	419-10-2	-30-055000 Specify number of pins 04-72
FIG. 4	Series 499...007	Right Angle Solder Tails
FIG. 4	499-10-2	-10-007000 Specify number of pins 04-64
  		
SPECIFY PLATING CODE XX=	10	
Pin Plating	10 μ Au	

