

Introducing the *TR*— Tough Rivet

Features and Benefits

- Made from a Super Tough Impact Modified UL94 HB Nylon 6/6 in black color
- Rivets are supplied pre-assembled and are easily installed by hand
- Fasten two or more materials together, mounts components or fan guards, or they can also mount other hardware into position
- Replaces the use of screw-nut assemblies or other mounting option

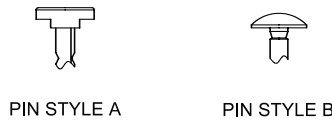
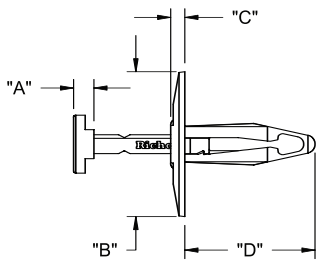
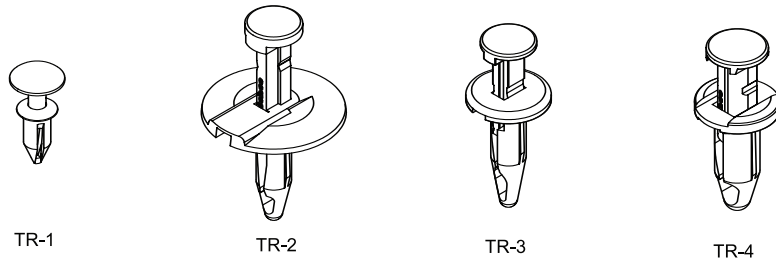
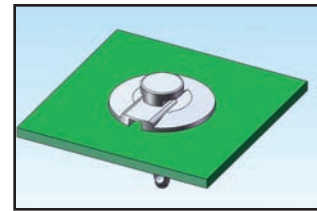
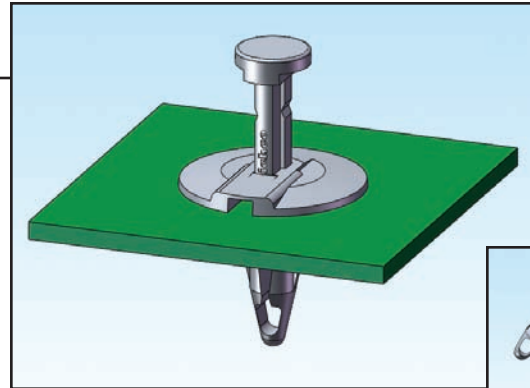

Markets

- Automotive
- Fans & Blowers
- Consumer Electronics
- Brown Goods
- White Goods
- Gaming & Vending Machines

Other Related Richco Product Solutions

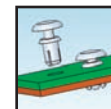

SR

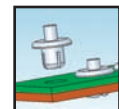

PPR

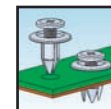

USR

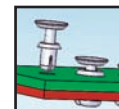

SRH

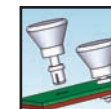

SRT

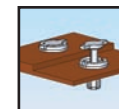

RRR

Material: Super Tough Impact Modified Nylon 6/6, RMS-73 Color: Black				Standard Pack: 1,000 per bag					
Part Number	Hole Diameter	Panel Thickness	"A"	"B"	"C"	"D"	No. of Legs	Pin Head Style	
TR-1	.193 - .205 (4.9 - 5.2)	.059 - .181 (1.5 - 4.6)	.100 (2.5)	.283 (7.2)	.045 (1.1)	.445 (11.3)	3	B	
TR-2	.248 - .276 (6.3 - 7)	.098 - .350 (2.5 - 8.9)	.140 (3.6)	1.000 (25.4)	.098 (2.5)	.898 (22.8)	2	A	
TR-3	.250 - .276 (6.4 - 7)	.098 - .315 (2.5 - 8)	.110 (2.8)	.590 (15)	.079 (2)	.830 (21.1)			
TR-4	.315 - .325 (8 - 8.3)	.118 - .315 (3 - 8)	.091 (2.3)		.106 (2.7)				