

## Introducing the **FCCB**— Arrowhead Mount Cable Clamp

### Features and Benefits

- Part easily mounts into pre-driven holes and is easily removed
- Tension wings provide extra pressure to the board to ensure a snug fit
- Two sizes accommodate different cable thicknesses
- Can be used for flat, ribbon or round cables
- Molded of a durable, UL94 V2 rated Nylon 6/6

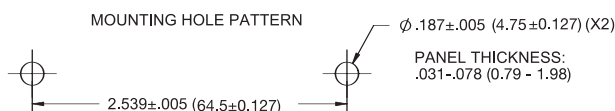
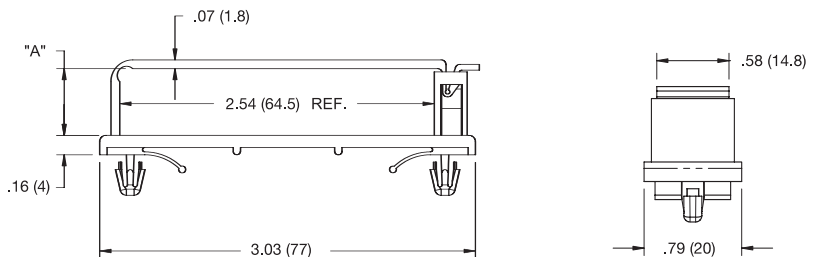
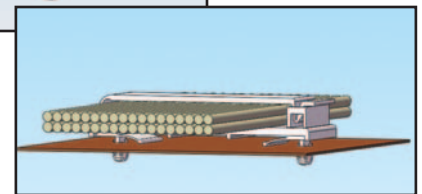
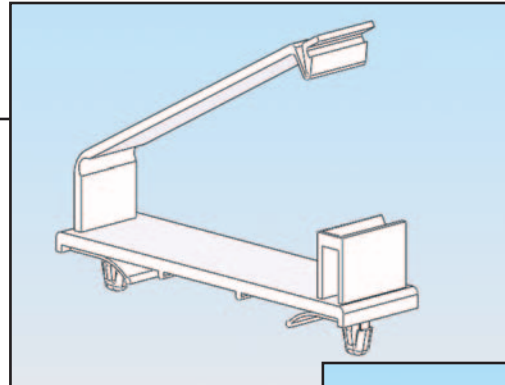

### Markets

- Consumer Electronics
- Office Equipment
- Gaming Machines
- Appliance
- Telecommunications
- Automotive

<b>Material:</b> Nylon 6/6, *RMS-01 <b>Color:</b> Natural	<b>Standard Pack:</b> 100 per bag
<b>Part No.</b>	<b>"A" Ref</b>
FCCB-1	.28 (7.2)
FCCB-2	.54 (13.7)
*Parts are available in UL94 V0 material by special order only. To order, add -19 to the end of the part number.	

### Other Related Richco Product Solutions



FCCA

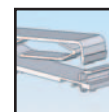

TFCCA



FCCE



HFCC

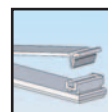

FCW

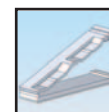

TFCM



RDAFCC

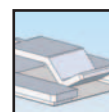

CFCCS