

Quadrax Connector Series

For Shell Sizes MIL-DTL-38999/20 & 26 | White Paper



Contents

3	MIL-DTL-38999 Quadrax Connectors
3	Background
3	High Speed Multi-Contact MIL-DTL-38999 Compliance
4	QPL Plug Sub Assembly MIL-DTL-38999 Compliance
5	Performance
5	Terms
5	Competitor Comparison
6	Reverse Gender Design
7	Eye Pattern
7	Test Capabilities
9	Appendix
9	Cable Testing Up to & Including 4 Gbps Data Rates
14	Contact Information

MIL-DTL-38999 Quadrax Connectors

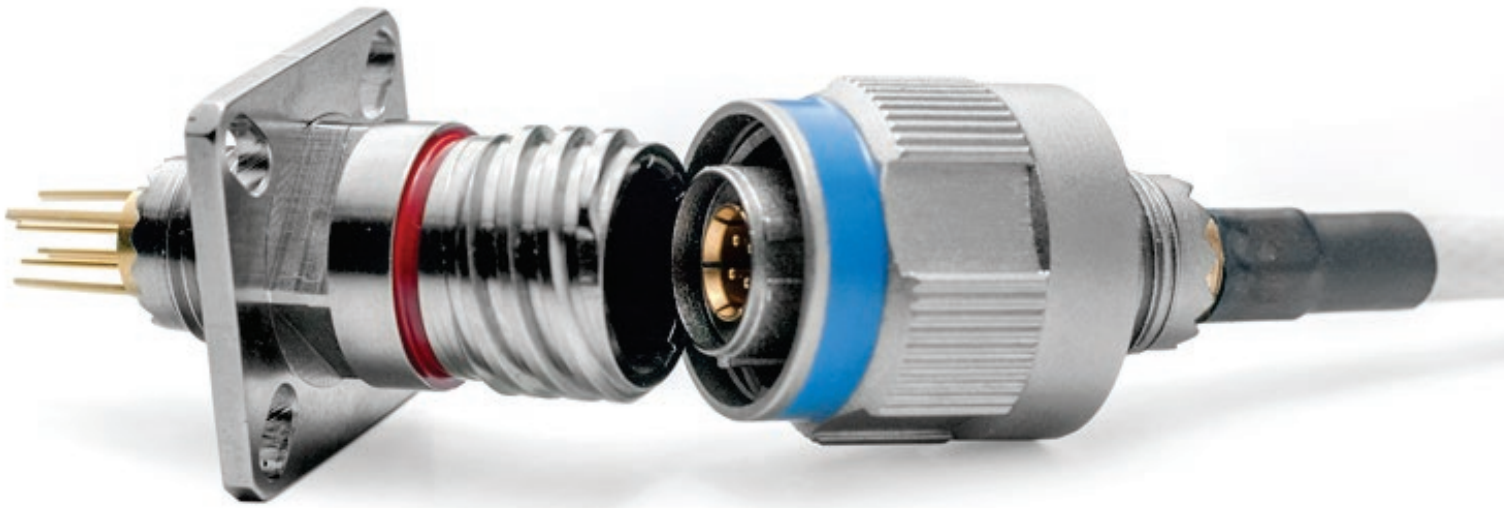

Background

Standard connectors such as MIL-DTL-38999 are intended for use as general purpose connectors in a variety of applications. As such, a wide ranging performance requirement is imposed on this connector to ensure its compliance with the environments in which it may be installed.

No QPL qualification has been developed for specialty connectors that share their format (partial configuration) with general purpose connectors, but are expected to perform differently. In most cases this results in the specialty connector exceeding the performance limits of QPL multipurpose connectors.

High Speed Multi-Contact MIL-DTL-38999 Compliance

Compliance with MIL-DTL-38999 specifications translates to meeting its requirements in three basic categories of dimensional, electrical performance and mechanical & environmental characteristics. Dimensional compliance with the requirements of this specification can be easily demonstrated by measurements. The electrical characteristics of the high speed connectors are not included in this specification and, as such, can only be compliant to specific customer requirements. The mechanical and environmental characteristics of these connectors require actual testing to demonstrate compliance.

Smiths Connectors, under an agreement, only uses qualified MIL-DTL-38999/26 connector plug sub-assemblies. This sub-assembly includes the connector housing,

the coupling mechanism (coupling nut) and the EMI shielding ground spring. Due to a specific common grounding requirement of these contacts, the traditional insulator mechanism of the general purpose MIL-DTL-38999 is replaced with a conductive insert assembly with an anti-rotational keying feature specifically for housing twinax and quadrax contacts.

QPL Plug Sub Assembly MIL-DTL-38999 Compliance

- 1. Coupling mechanism resistance to vibration and shock environments**
Subject coupling mechanism has been qualified to all applicable dynamic environmental testing.
- 2. EMI shielding effectiveness**
The EMI shielding spring is contained in the qualified plug sub-assembly. The mating receptacle connector's dimensional compliance allows the same shielding effectiveness to be reached.
- 3. Environmental sealing of the mated connector**
This function is achieved via engagement between the peripheral seal (a component of the qualified plug sub-assembly) and the receptacle connector front face.
- 4. Insert specially designed for use with quadrax or twinax contacts**

The quadrax contact consists of an outer shield with four inner conductors paired orthogonally forming two 100 Ohm controlled impedance differential pairs. An alignment key is machined onto the body of the quadrax contact. Smiths Connectors' design engineering ensures that the quadrax contact maintains constant impedance and that each and every discontinuity is properly compensated to minimize reflections and preserve signal integrity. The first eye pattern shows a contact that was not design for constant impedance through the entire contact. The second eye pattern shows a contact designed with a constant impedance of 100 ohms through the entire contact.

Eye Pattern Without Match Impedance Quadrax at 1 Gbps

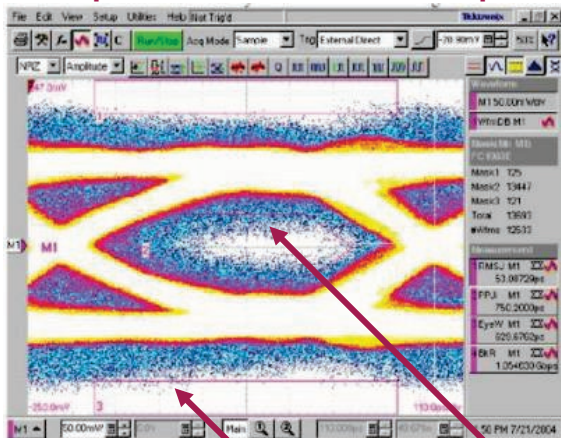

Eye Lash

Keep Out Region

Eye Pattern With Match Impedance Quadrax at 1 Gbps

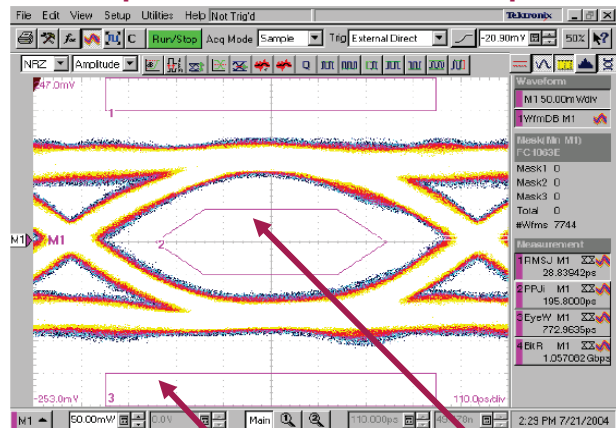

Eye Lash

Keep Out Region

Performance

Terms

- ▶ Signal Integrity: ensuring properly shaped pulses reach the receiver from the transmitter
- ▶ Eye Pattern: a graph which overlays thousands of pulses as an easy way to evaluate signal integrity
- ▶ Skew: difference in time delay between different signal paths
- ▶ Jitter: noise induced timing error

Competitor Comparison

Comparison of Smiths Connectors' quadrax design against a competitive offering

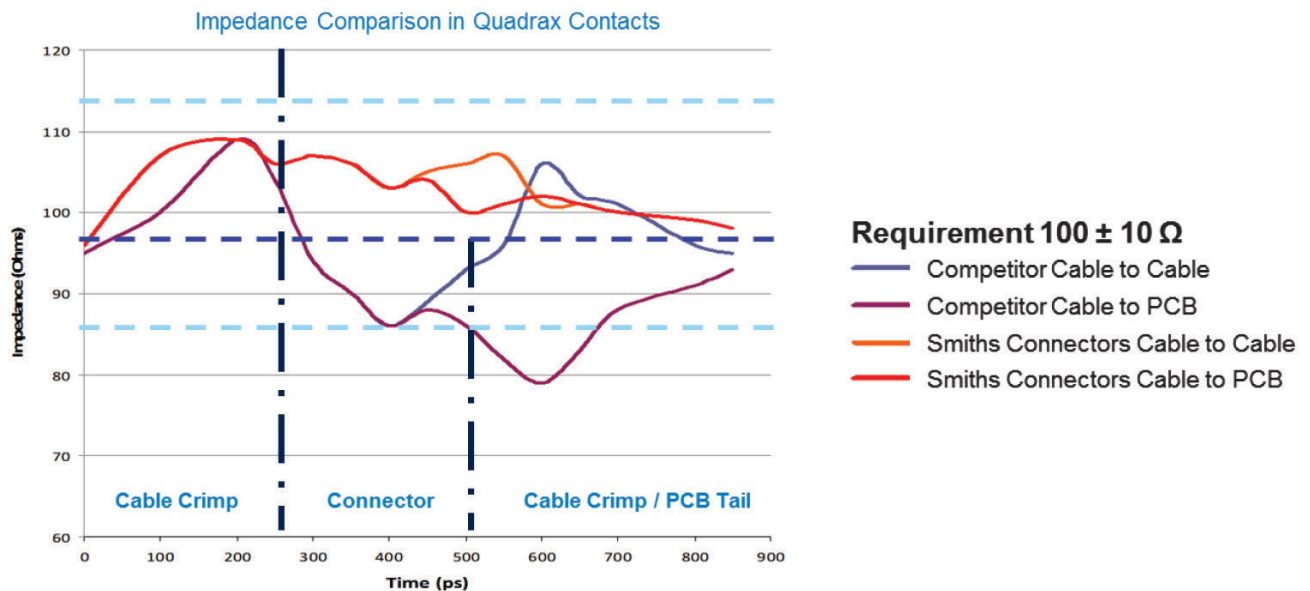

Competitor connector performance is below the $100 \pm 10 \Omega$ threshold.

Quadrax contacts offer several advantages for high data transfer rates, low power consumption and excellent EMI compatibility:

- ▶ Four strategically spaced inner contacts form two 100 Ohm matched impedance differential pairs
- ▶ Outer contact has rugged wall section
- ▶ Available in size 8 crimp termination style
- ▶ Size 8 pin also available with pc tails
- ▶ Requires modification of MIL-DTL-38999 connector to accommodate keyed contacts

The alignment key is inserted into the slot which is manufactured into each contact location within the 38999 insert arrangement. The alignment key and the slot help to ensure that the signal contacts within the quadrax contact are populated at the same mechanical and electrical position every time.

Reverse Gender Design

In a traditional quadrax design, the four inner pin contacts protrude from the insulator surface. Because of the contact pins' small gage, there is potential for the contacts to be bent or damaged during assembly and handling. This could lead to problems when the connectors are mated as contacts with just the smallest misalignment could experience breaking or bending. In some cases the pins could damage the mating socket contact or puncture the mating contact dielectric material.

To avoid this potential problem, Smiths Connectors' quadrax design is reverse gender. The inner quadrax pin is recessed within the dielectric material. The inner socket contact is exposed air dielectric and protruding from the insulator front surface.



Benefits of reverse gender design:

- ▶ Better blind mate capability
- ▶ Reduced chance of bent inner pins
- ▶ Larger, heat-treated rigid socket contacts protruding from the insulator surface

In the MIL-DTL-38999 receptacle, the termination style can be cable mount, crimp, or straight pc tail. In the straight pc tail version the contacts are included when the MIL-DTL-38999 receptacle connector is purchased.

The quadrax pin and socket contacts are designed to terminate to 100 Ohm quadrax cable 540-1183-000. Eye pattern tests were performed on the quadrax contacts with quadrax cable lengths of 10' – 50'. The eye patterns were recorded at data rates of 1 Gbps, 2 Gbps, 3 Gbps and 4 Gbps. The test report is available in the Appendix section.

Eye Patterns

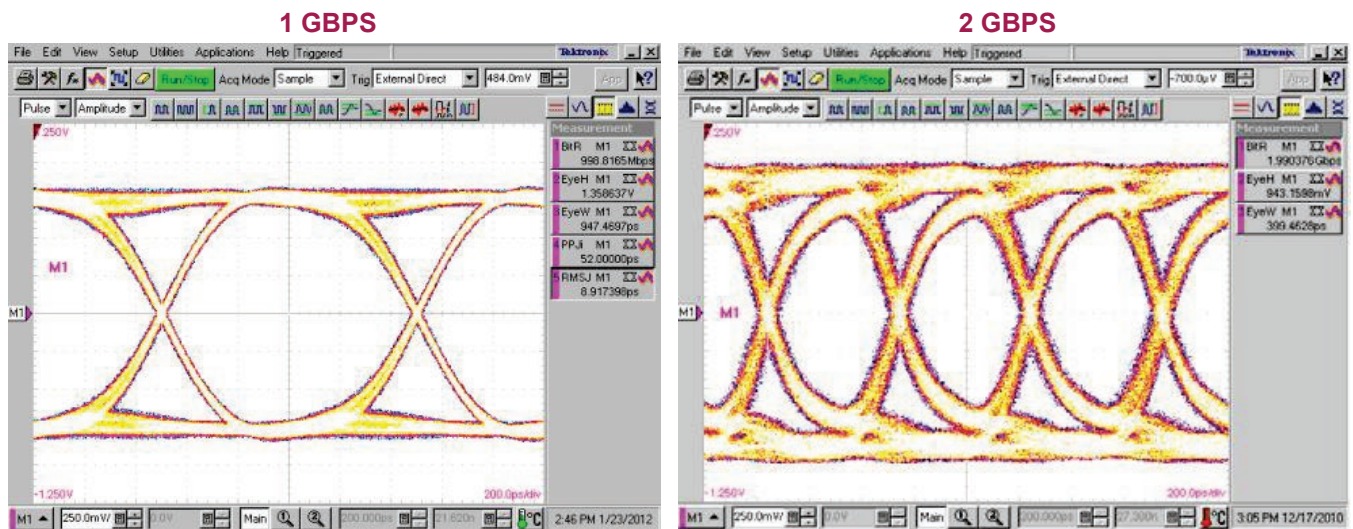

Testing Capabilities

Smiths Connectors quadrax interconnects are characterized for testing eye pattern, jitter, skew, and insertion loss on differential pair 100 Ohm high speed Gigabit Ethernet applications with a wide variety of testing protocols. The Agilent E5071C 4 port network analyzer is used to measure the differential pair TDR impedance between quadrax connectors, cable assemblies, quad cable, Ethernet and Fibre Channel interconnect systems ensuring the most accurate acquired signal for high speed communications testing.

The E5071C 4 port network analyzer is capable of highly accurate 100 Ohm differential measurements up to 20 GHz and can measure Eye Diagrams up to 16 Gbps.

MIL-STD-1560 is the specification that identifies the different insert arrangements that can be used with 38999 connectors. Most inserts that are designed for use with size 8 contacts can be utilized with quadrax contacts. The following inserts are the most popular arrangements with the use of quadrax contacts. If a particular insert needed for your application is not shown please contact Smiths Connectors.

Insert Arrangements

17-82 (2 #8)

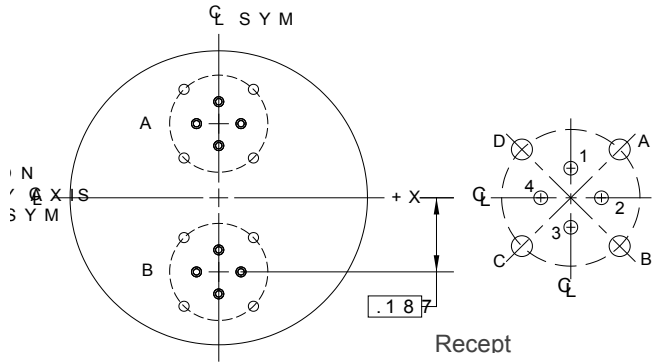

19-4 (4 #8)

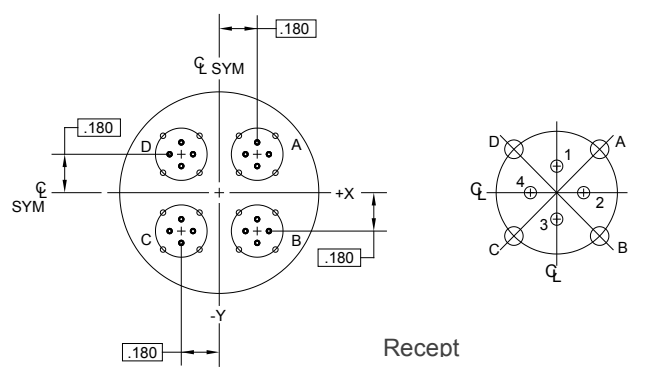

23-6 (6 #8)

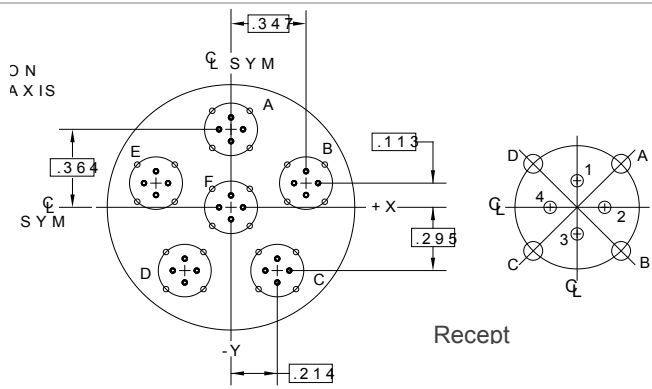

25-8 (8 #8)

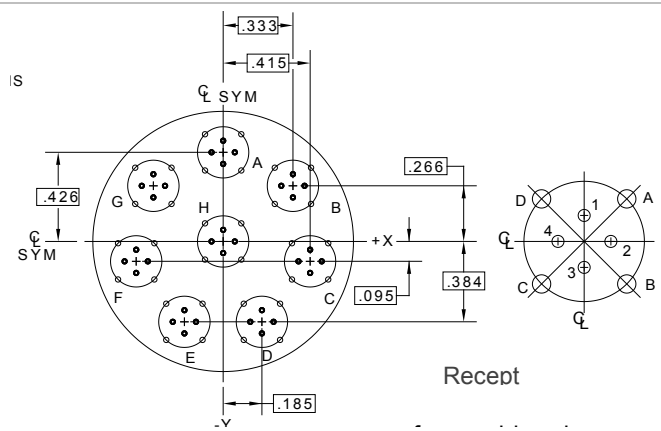

Appendix

Between any transmitter and receiver (or two transceivers where applicable) lie various possibilities to damage your signal. Aside from the straight resistive losses (of the cable or printed circuit board trace) which reduce the voltage level of the signal, there lurk many other unwanted perturbations to the transmitted signal that may render it unrecognizable to the receiver. These include frequency dependent reflections of interconnects, frequency dependent losses of the dielectric media surrounding the traces or cable wires, impedance mismatches at every separable interconnect and electromagnetic interferences of various degrees.

Smiths Connectors recognizes these issues and strives to offer numerous product choices to engineers ensuring designs are optimized for peak performance. To that end Smiths Connectors has characterized many of the cables used in the assemblies of our connector/contact systems.

The following eye pattern diagrams show qualitatively the expectant results of a well-terminated cable contact system.

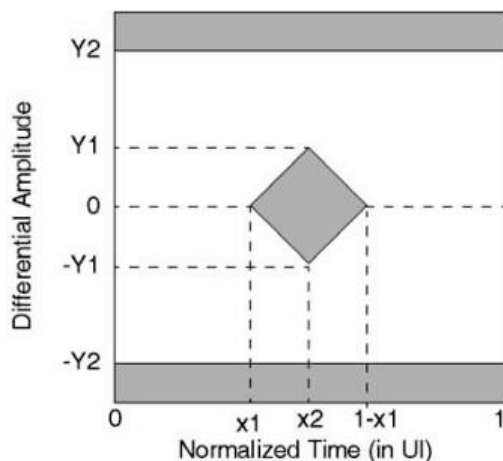

Figure 31 – Eye diagram mask at point-R'

Table 12 – Eye diagram mask at point-R'

	Bit rate (Mbaud)	X1	X2	Y1 (mV)	Y2 (mV)
Intra-enclosure	132,818.5	0,29	0,5	200	800
	265,625	0,29	0,5	200	800
	531,25	0,29	0,5	200	800
	1 062,5	0,29	0,5	200	800
Inter-enclosure	132,818.5	0,28	0,5	200	1000
	265,625	0,28	0,5	200	1000
	531,25	0,28	0,5	200	1000
	1 062,5	0,28	0,5	200	1000

Using the Fibre Channel EPD mask as a reference (shown above) listed below are the various lengths of cables that “pass” the spec for 1Gbps rate.

Note: it is important to understand the receiver sensitivity limits to design a robust system. Commercial specifications like FC are intentionally written more strictly defined so that interoperability issues between various manufacturers can be tolerated.

To explain the test set-up, the signal generation and measurement were performed on a Tektronics CSA8000 Communications Signal Analyzer. A pair of phase matched 50 Ohm SMA high speed coax cables brought the differential signal from the test head to an ‘SMA to quadrax’ PCB interface board or an equivalent ‘SMA to

twinax' PCB interface board depending on the type of contact/cable to be evaluated. A 50' section of cable was appropriately terminated; measurements were then made and recorded starting 4Gbps, 3Gbps, 2Gbps and 1Gbps. The cable was then reduced by 10', re-terminated and the same measurements repeated.

Since weight and volume are both significant design considerations, three different cables were tested:

- [A] 24 AWG quadrax
- [B] 24 AWG twinax
- [C] 26 AWG twinax

Note: As with any high speed interconnect care was taken in the cable preparation and termination to ensure that the cable-contact-cable transition was optimized.

The 24 AWG twinax performed the best of the three cable assemblies tested. The raw data is charted in the table.

	Center Eye Height In Mvolts					Eye Width In Psec				
	10 ft	20 ft	30 ft	40 ft	50 ft	10 ft	20 ft	30 ft	40 ft	50 ft
24 AWG Quad	1400	1000	650	450	100	925	865	755	585	275
24 AWG Twin	1400	1100	800	600	400	930	880	800	715	675
26 AWG Twin	1300	1000	700	450	375	920	850	735	710	370

Comparing this data to the FC Normalized Eye Diagram mask the colored cells meet or exceed the specification. Since the data includes a mated connector pair and a length of printed circuit board on each end the specific performance in your design should correlate very well. A brief evaluation of the data shows excellent performance for Gigabit data rates on 24 AWG twinax cable well out to 50'. Interestingly, the 26 AWG twinax cable performed as well or better than the 24 AWG quadrax across all lengths. The data was culled from a visual inspection of the resultant EPD for each cable, at each data rate. As a reference the 30' and 50' 24 AWG twinax cable EPD's are shown side by side.

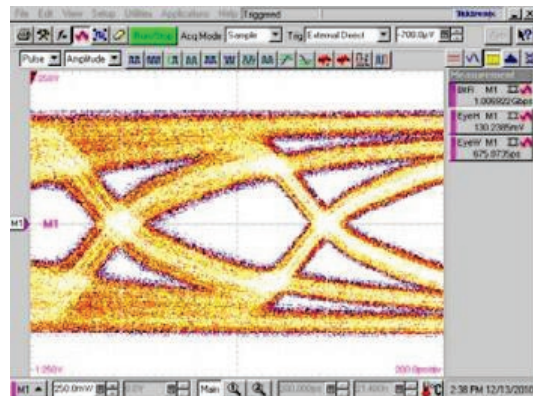
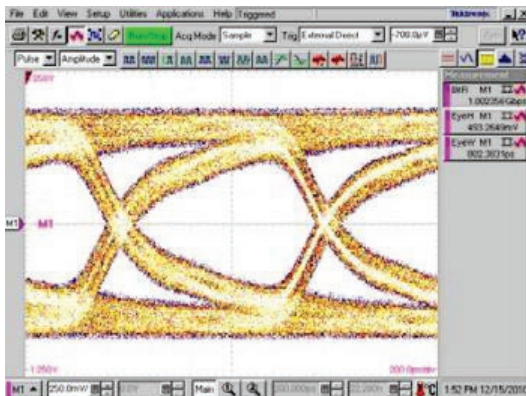

What is of particular interest is the lack of reflections, caused by any impedance discontinuities, in the entire signal path. This shows a well conceived and executed design strategy. Also, both the eye height voltage and the eye width jitter components are very well behaved.

Of course depending upon the particular driver and receiver characteristics the cable lengths and data rates attained can be improved. In addition, with various signal conditioning tools widely available in the industry (such the passive equalization contacts from Smiths Connectors) even longer cable lengths and faster data rates could be achieved.

The test results for higher data rate testing are provided in tabular format. For reference, we maintained the structure of comparing the data to a “projected FC” data rate of 2Gbps, 3Gbps and 4Gbps (actual data rate of 2.125, 3.1875 and 4.25 Gbps respectively). This means the Eye Height was required to exceed a 400mV differential limit, while the Unit Interval (UI) mask requirement was maintained at [UI*.58]

The 24 AWG twinax assembly passed a valid FC mask requirement at 10' length for all data rates up to 4 Gbps. The 24 AWG quadrax and 26 AWG twinax had a valid voltage level at the 4Gbps rate, though the UI eye width missed complying with the specification by only 10pSec. (125ps measurement versus a 135ps requirement).

The results, though not linear, do track with the 1Gbps data as expected. For the designer of high speed I/O this means that for shorter distances (< 3 m) and data rates below 4 Gbps there are many options when selecting a contact-cable assembly. In addition, Smiths Connectors offers extremely well-designed, tightly controlled assemblies for those systems where high speed data rates are necessary.

Higher Data Rates

Shown below for all data rates is an example of an EPD for the 10', 24 AWG twinax assembly, along with the tabulated data measured across all three assemblies.

2 GBPS

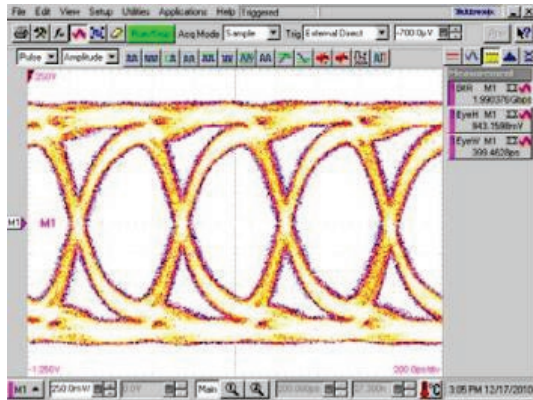

	Center Eye Height In Mvolts					Eye Width In Psec				
	10 ft	20 ft	30 ft	40 ft	50 ft	10 ft	20 ft	30 ft	40 ft	50 ft
24 AWG Quad	1100	500	100	--	--	390	310	155	--	--
24 AWG Twin	1100	800	400	--	--	395	390	255	--	--
26 AWG Twin	1050	600	200	--	--	385	330	165	--	--

3 GBPS

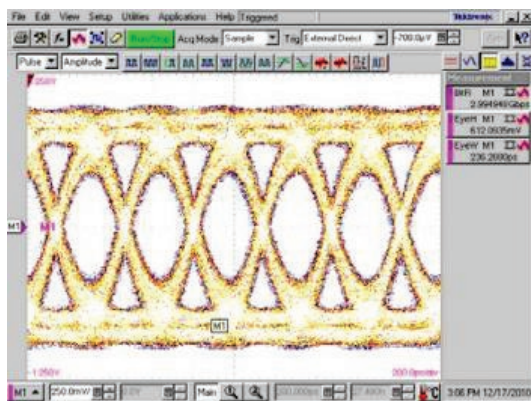

	Center Eye Height In Mvolts					Eye Width In Psec				
	10 ft	20 ft	30 ft	40 ft	50 ft	10 ft	20 ft	30 ft	40 ft	50 ft
24 AWG Quad	700	175	0	---	---	220	150	0	---	---
24 AWG Twin	700	400	150	---	---	235	186	25	---	---
26 AWG Twin	650	250	0	---	---	220	125	0	---	---

4 GBPS

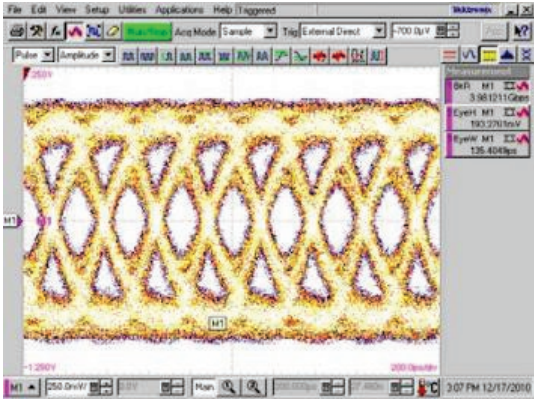

	Center Eye Height In Mvolts					Eye Width In Psec				
	10 ft	20 ft	30 ft	40 ft	50 ft	10 ft	20 ft	30 ft	40 ft	50 ft
24 AWG Quad	400	0	---	---	---	125	0	---	---	---
24 AWG Twin	500	100	---	---	---	135	60	---	---	---
26 AWG Twin	400	0	---	---	---	120	0	---	---	---

Smiths Connectors Global Support

AMERICAS

Costa Mesa, CA	1.714.371.110	customerservice@sabritec.com
Hudson, MA	1.978.568.0451	info@hypertronics.com
Kansas City, KS	1.913.342.5544	info@idinet.com

EUROPE

France	33.2.3296.9176	info@hypertac.fr
Germany	49.991.250.120	info@hypertac.de
Italy	39.010.60361	info@hypertac.it
United Kingdom	44.208.236.2400	info@hypertac.co.uk

ASIA

Shanghai, China	86.21.3318.4650	asiacrs@smithsconnectors.com
Singapore	65.6846.1655	asiacrs@smithsconnectors.com
Suzhou, China	86.512.6273.1188	asiacrs@smithsconnectors.com

FOR MORE INFORMATION | smithsconnectors.com

Disclaimer 2015

All of the information in this test report is believed to be accurate at the time of printing. It is recommended, however, that users independently evaluate the suitability of each product for their intended application and be sure that each product is properly installed, used and maintained to achieve desired results. Smiths Connectors makes no warranties as to the accuracy or completeness of the information, and disclaims any liability regarding its use.

Smiths Connectors reserves the right to modify design and specifications, in order to improve quality, keep pace with technological development or meet specific production requirements.

No reproduction or use without express permission of editorial and pictorial content, in any manner